

## Pin Assignment

Terminal blocks:

20A/300Vac, M3.5, 0.5~2.0mm<sup>2</sup> (22~14AWG)

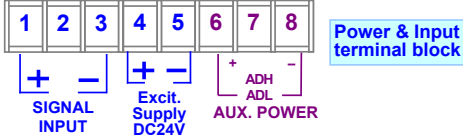

## OUTPUT

### Relay output

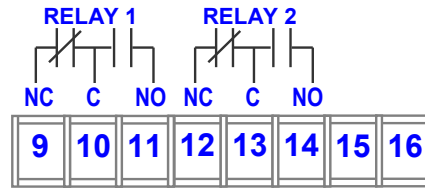

If power connection noise interference, install the EMC Filter

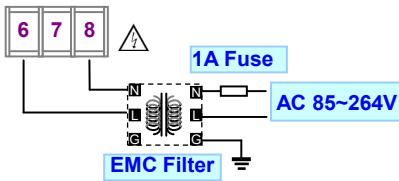

### Analog output

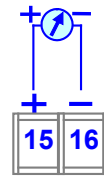

### RS485 port

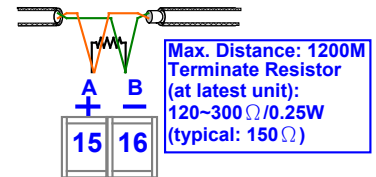

### Signal Input

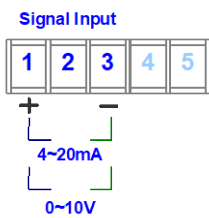

### 2 wire sensor Input connection

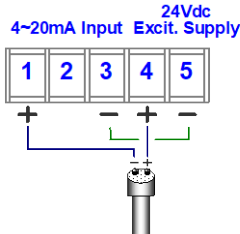

## FRONT PANEL

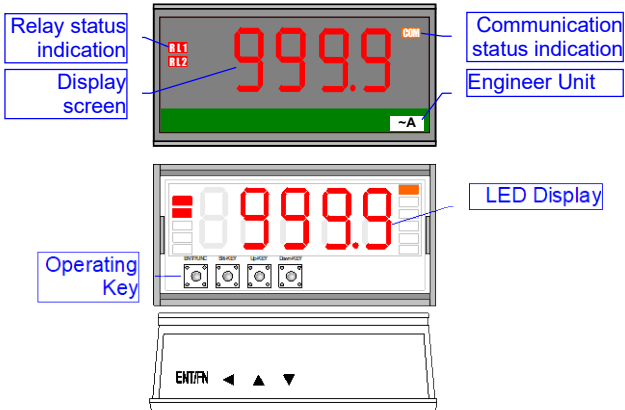

### Number screen:

88888: red high-brightness LED for 4 digital present value **Output LED:**

### Relay Energized: 2 square red LED

**RL1** display when Relay 1 energized

**RL2** display when Relay 2 energized;

**COM** **RS485 Communication:** 1 square orange LED; **COM** will flash when the meter is receive or send data, and **COM** flash quickly means the data transient quicker. ◦

**Operating Key:** 4 keys for Enter(Function) / Shift(Escape) / Up key / Down key





















## ■ OPERATING KEY:

\*Please access to the Programming Level to check and set the parameters when users start to run the meter

■ **Operating Key:** 4 keys for  Enter(Function) /  Shift(Escape) /  Up key /  Down key

■ The meter has designed operation similar as PC's   and . In any page, press  key means "enter" or "confirm setting", and press  key means "escape()" or "shift".

■ In Programming Level, the screen will return to Measuring Page after do not press any key over 2 minutes, or press  for 1 second.

	Function Index	Setting Status
 (=  ) <b>Enter/Fun key</b>	(1) In any page, press  to access the level or function index (2) From the function index to access setting status	(3) Setting Confirmed, save to EEPROM and go to next function index
 (=  ) <b>Shift key</b>	(1) In measuring page, press  for 1 second to access user level. (2) In function index, press  for 1 second to go back upper level. (3) In function group index, press  for 1 second to go back measuring page	(4) In setting status, press  to Shift the setting position. (5) In setting status, press  for 1 second to abort setting and go back this function index.
 (=  ) <b>Up key</b>	(1) In function index, press  to go back to previous function index	(2) In setting status for function, press  to select function (3) During number Setting, press  can roll the digit up
 (=  ) <b>Down key</b>	(1) In Function Index Page, press  will go to the next Function Index Page.	(2) In setting status for function, press  to select function (3) During number Setting, press  can roll the digit down.

# OPERATING DIAGRAM

(The detail description of operation, please refer to operating manual.)

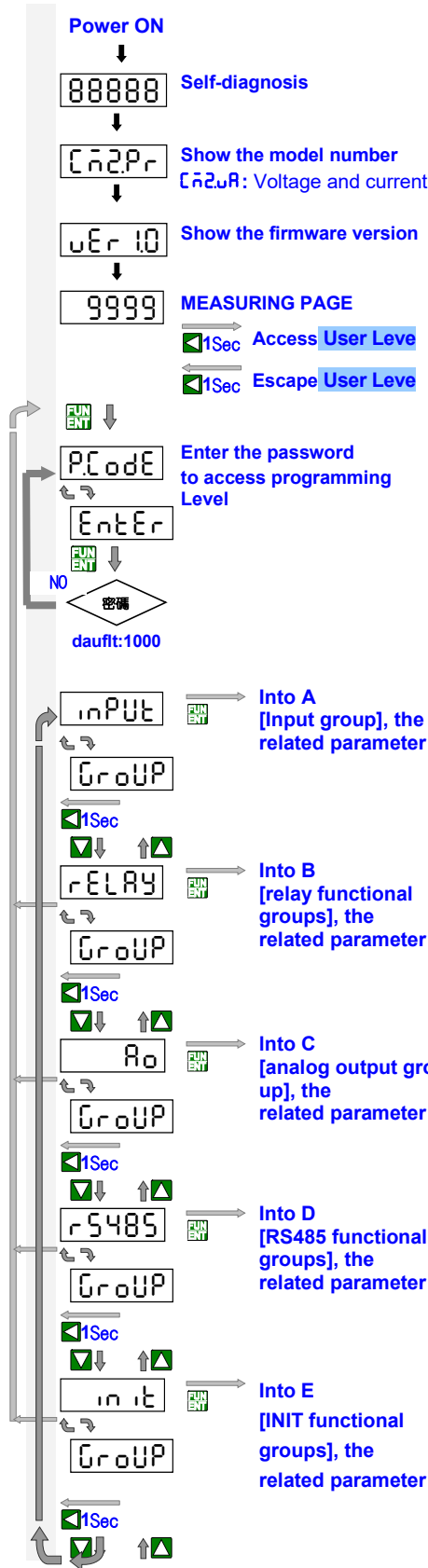

## User Level

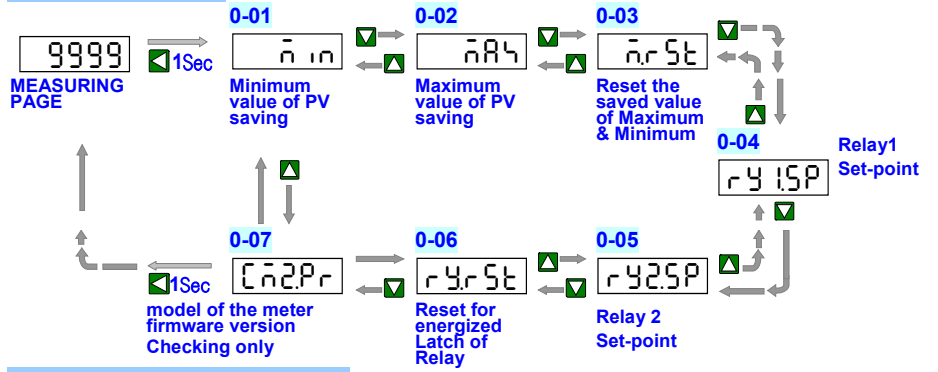

## Programming Level

### A. INPUT GROUP

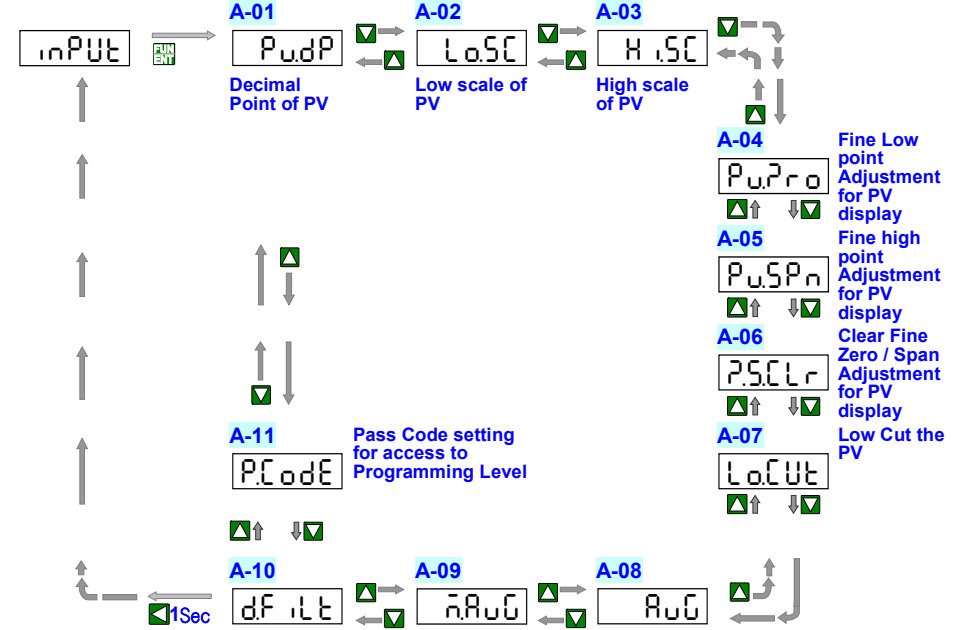

### B. RELAY GROUP

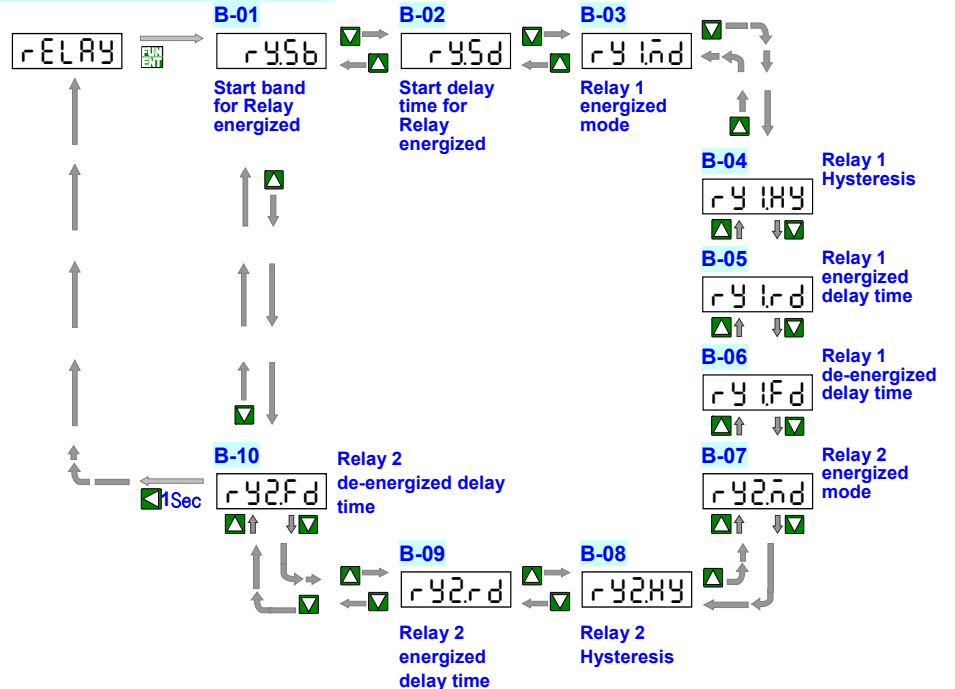

### C. ANALOG OUTPUT GROUP

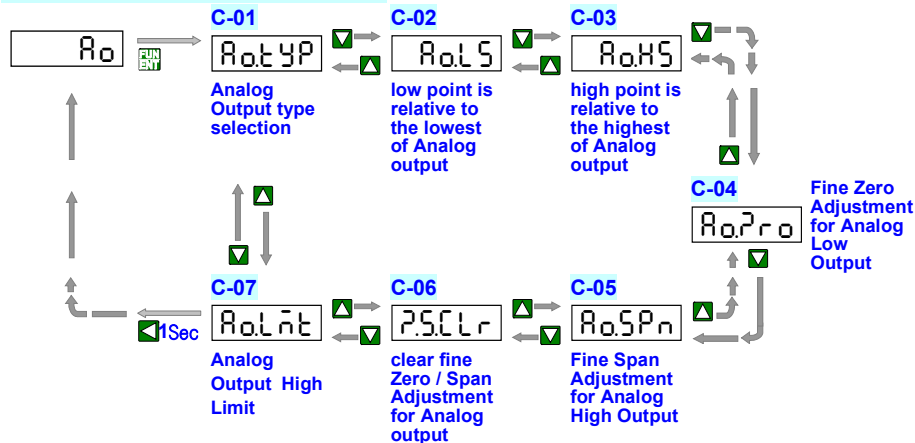

### D. RS485 GROUP

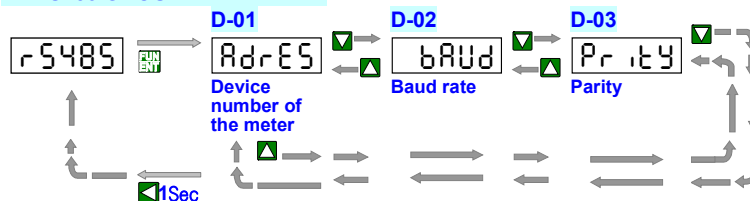

### E. INIT GROUP

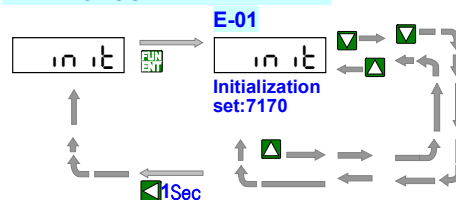

## ADDRESS TABLE \*\*Address number are Hexadecimal

### User Level

Name	Address	Range	Explain	Initial	Write/Read	Note
Pv	0000h	-1999~9999	Present Value		R	
n in	0001h	-1999~9999	The Minimum of PV	0	R	
nAR	0002h	-1999~9999	The Maximum of PV	0	R	
n.rSt	0003h	0~1	Clear Max/Min of PV 0:NO 1:YES	0	R/W	

### Engineer Level

【Input Group】						
Name	Address	Range	Explain	Initial	Write/Read	Note
PvdP	0005h	0~3	PV Decimal Point 0: 0000 1: 000.0 2: 000.0 3: 0.000	0	R/W	
LoSC	0006h	-1999~9999	Low Scale	0	R/W	
HiSC	0007h	-1999~9999	High Scale	9999	R/W	
LoCut	0008h	-1999~9999	Low Cut	0	R/W	
Avg	0009h	1~99	Average	5	R/W	
nAvg	000Ah	1~99	Moving Average	8	R/W	
dFilt	000Bh	1~99	Digital Filter	8	R/W	
PCode	000Ch	0000~9999	Pass Code	1000	R/W	

【RS485 Group】						
Name	Address	Range	Explain	Initial	Write/Read	Note
AdRES	000Dh	1~247	RS485 address	1	R/W	
bAUD	000Eh	0~5	RS485 baud rate 0:1200 1:2400 2:4800 3:9600 4:19200 5:38400	3	R/W	
Pr tY	000Fh	0~3	RS485 parity 0: n-8-1 1: n-8-2 2: odd-8-1 3: even-8-1	1	R/W	

【INIT Group】						
Name	Address	Range	Explain	Initial	Write/Read	Note
in it	0010h	0000~9999	Initialization (code:7170)	0000	R/W	

【Relay Group】						
Name	Address	Range	Explain	Initial	Write/Read	Note
rY5b	0011h	0~9999	Start Band of Relay	0	R/W	
rY5d	0012h	0~5999	Start Delay Time of Relay	0	R/W	
rY1SP	0013h	-1999~9999	Relay 1 Set Point	1000	R/W	
rY1nd	0014h	0~4	Relay 1 Energized Mode 0:OFF,1:LO,2:HI,3:LO.HLD,4:HI.HLD	2	R/W	
Ry1 Control	0015h	0~1	Relay 1 status 0 : OFF 1 : ON		R/W	
rY1HY	0016h	0~5000	Hysteresis of Relay1	0	R/W	
rY1rd	0017h	0~5999	Energized Delay Time of Relay1	0	R/W	
rY1fd	0018h	0~5999	De-Energized Delay Time of Relay1	0	R/W	
rY2SP	0019h	-1999~9999	Relay 2 Set Point	1000	R/W	
rY2nd	001Ah	0~4	Relay 2 Energized Mode 0:OFF,1:LO,2:HI,3:LO.HLD,4:HI.HLD	0	R/W	
Ry2 Control	001Bh	0~1	Relay 2 status 0 : OFF 1 : ON		R/W	
rY2HY	001Ch	0~5000	Hysteresis of Relay 2	0	R/W	
rY2rd	001Dh	0~5999	Energized Delay Time of Relay 2	0	R/W	
rY2fd	001Eh	0~5999	De-Energized Delay Time of Relay 2	0	R/W	